

BAVARIAN POLYMERS

5050 SERIES DUAL PANEL SLIDING GLASS DOOR

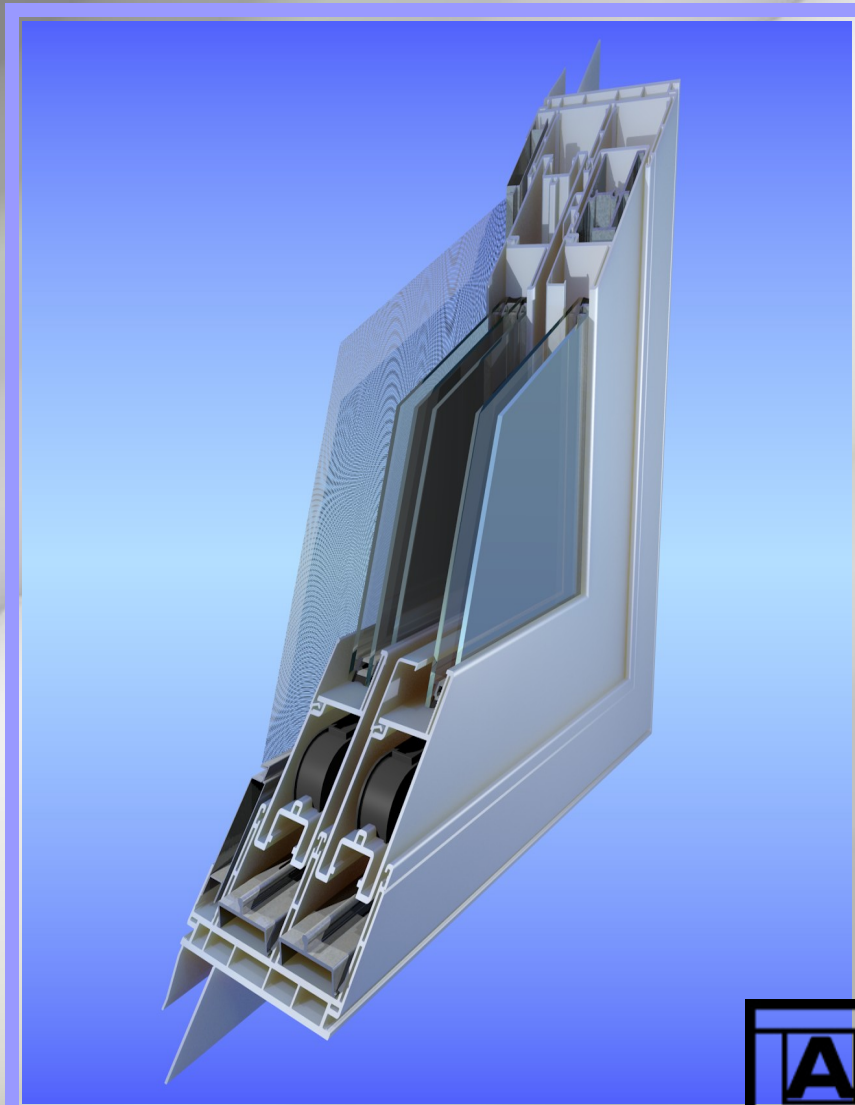

DUAL PANEL – DP50 – 1-1/4" IG – IMPACT – R5 – INTEGRAL J-CHANNEL

White, Tan or Clay Vinyl - Laminates available in either wood grains or color

FEATURES AND BENEFITS

FRAME

- Typical wall thickness .075"
- 4-9/16" frame depth; accessory/trim grooves inside and outside
- Weep slots do not interfere with accessory grooves
- Available configurations: XX, OX, XO, OXO, OXXO
- .750" x .800" integral siding J-Channel; can be slit off inline
- Removable nailing fin (1-1/4" set-back) for retro-fit (flush) applications
- Installation screw supports in panel track
- Dual weatherstripping all around
- Removable panel and screen roller tracks (aluminum)
- Snap-in cover for unused track is available; no exposed installation screws
- Most accessory parts fit optional direct-glazed frame

PANELS

- Typical wall thickness .075"
- 7/8" glazing leg height
- Exterior-glazed; designed for impact testing to Miami-Dade and ASTM standards
- 1-9/16" x 3" profiles; 3/4" glass penetration
- Panel and interlock profiles also used in optional direct-glazed frame
- Panel stiles and rails are the same profile
- Equal glass size for manufacturing efficiency and grid alignment
- Mortise lock recessed into leadstile groove for increased stile penetration into jamb
- Fixed panel (XO, OX, etc.) requires no rollers or locks
- 3/16" (minimum) take-out clearance
- Glazing options from 3/4" I.G. to 1-1/4" I.G.
- Glass stops snap in perpendicular to the glazing for ease of insertion
- Dual-weatherstripped integral interlocks
- Large interlock hollows for optional high-performance reinforcement
- Interlock reinforcement is identical in both panels

HARDWARE

- Designed to accept a wide range of single and multi-point locks & trim-sets
- Secondary locks (thumb-turn) are an option to multi-point locks
- Designed to accept almost any commercially available roller assembly
- Single or tandem wheels and end or side-adjust rollers are optional
- Anti-lift out devices are available
- Designed to accept a wide variety of sill weep hole covers

PERFORMANCE

- DP50 possible in a 8'0"/8'0" door size with the proper reinforcement
- U-value: 0.25 (R4) with 7/8" IG & dual low-E; U0.18 (R5.6) possible with triple-glazed 1-1/4" IG
- Zone 4 impact rating possible when the required interlayer and sealant is utilized
- Forced Entry Resistance (FER) rating is dependent on the lock hardware specified

Possible Configurations

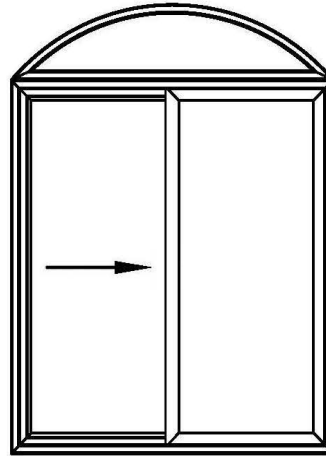



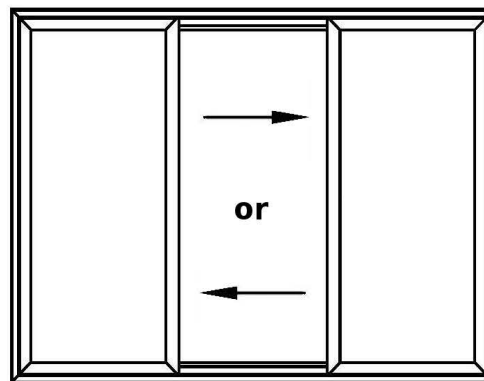



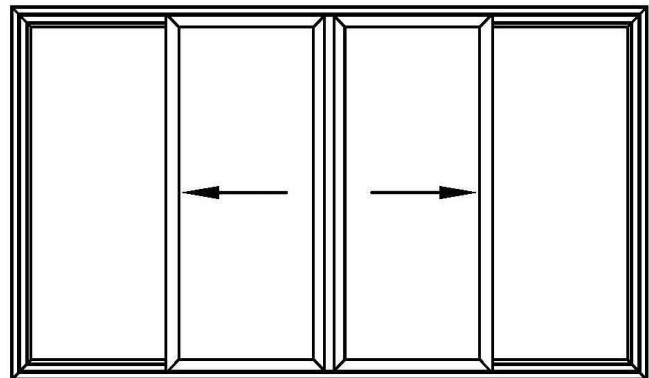

XO (OX) or XX

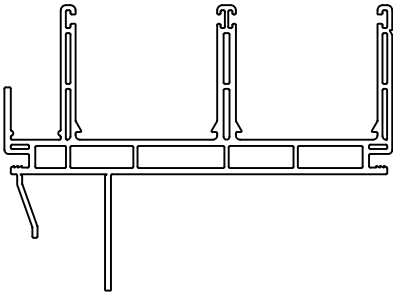

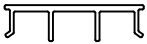
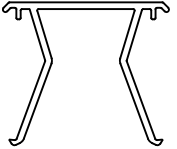
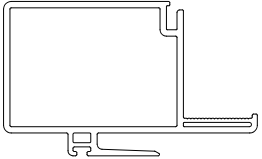
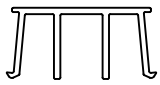
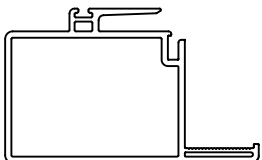
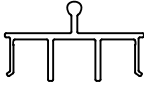
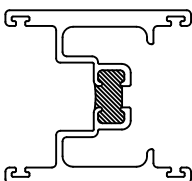
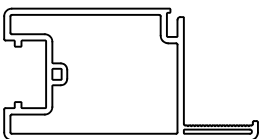
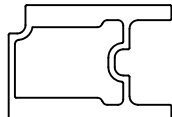
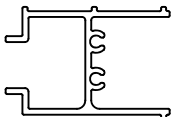
OXO

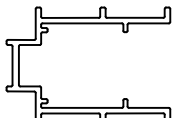

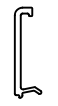
OXXO

GRAPHICS-VINYL	DESC.	PART#	GRAPHICS VINYL (CON'T.)	DESC.	PART#
	DIRECT-GLAZED MAINFRAME	XV-5052		1-1/4" GL. STOP	XV-5061
				ANTI-LIFT CLIP & KEEPER SHIM	XV-5063
				INT. JAMB COV./ PAN. STOP (PVC)	XV-5064
	EXTERIOR INTERLOCK	XV-5053		FIX. PAN. SPACER	XA-5062
			GRAPHICS ALUMINUM		
	INTERIOR INTERLOCK	XV-5054		PANEL ROLLER TRACK	XA-5072
				DXXD ASTRAGAL	XA-5078
	HORIZ. RAIL & VERT. STILE	XV-5055		H.D. INTLK. REINF.	XA-50112
				STD. INTLK. REINF.	XA-5093
	3/4" GL. STOP	XV-5057		RAIL & STILE REINFORCEMENT	XA-5090
	7/16" GGL. STOP	XV-5058			
	1-1/8" GL. STOP	XV-5060		SCREEN ROLLER TRACK	XA-5091

Part No: **5050**

Revision: N/A

Title: SERIES 5050 TWO-TRACK SLIDING GLASS DOORS

Drawing No: G-5050-6

AMESBURY HARDWARE

CAD Scale: 1:1

Drawn By: RJK

Approved By: _____

Date: 11-10-11

Material: Poly-Vinyl Chloride (PVC)

BAVARIAN POLYMERS

The material contained herein is proprietary and confidential to BAVARIAN POLYMERS and any unauthorized use, duplication, or dissemination of this material, without the expressed written consent of Bavarian Polymers, is strictly prohibited.

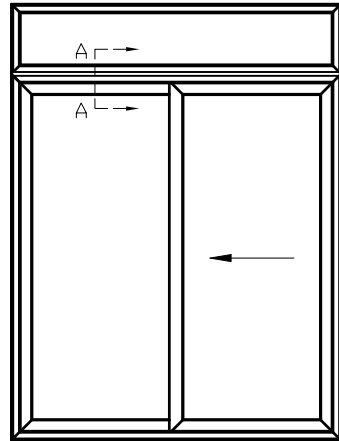
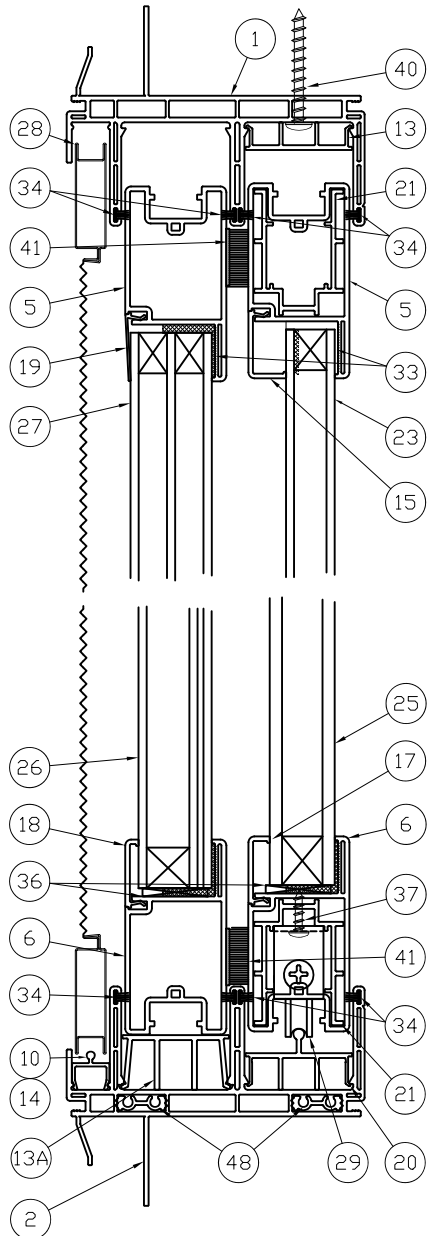

XD - INTERIOR ELEVATION

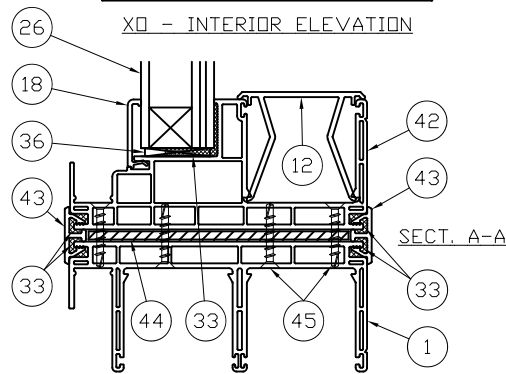

SECT. A-A

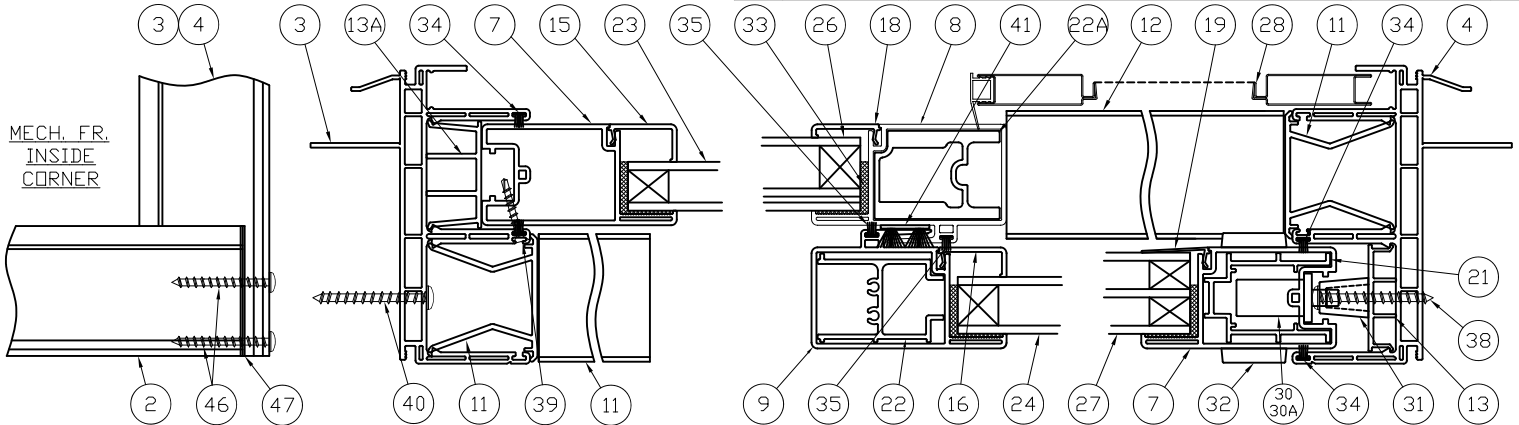

MECH. FR. INSIDE CORNER

ITEM	PART NO./SIZE	DESCRIPTION	FAB. DWG/NOTES	VENDOR/SIZE	QTY.
1	5052	FRAME HEAD	F-5052-1	BAVARIAN	1
2	5052	FRAME SILL	F-5052-2A, 7	BAVARIAN	1
3	5052	FRAME FIXED-SIDE JAMB	F-5052-4, 5	BAVARIAN	1
4	5052	FRAME LOCK-SIDE JAMB	F-5052-1, 5	BAVARIAN	1
5	5055	PANEL TOP RAIL	F-5055-1A, 4	BAVARIAN	2
6	5055	PANEL BOTTOM RAIL	F-5055-1A, 4	BAVARIAN	2
7	5055	PAN. LOCK STILE & FIX. PAN. STILE	F-5055-2B, 3A	BAVARIAN	1 ea
8	5053	FRAME EXTERIOR INTERLOCK	F-5053-3	BAVARIAN	1
9	5054	PANEL INTERIOR INTERLOCK	F-5054-1-1	BAVARIAN	1
10	5065	VINYL SCREEN ROLLER TRACK	F-5065-2	BAVARIAN	1
11	5064	JAMB COVER & PANEL STOP	F-5064-1	BAVARIAN	2/2
12	5064	HEAD & SILL COVER	F-5064-1	BAVARIAN	1 ea
13	5063	ANTI-LIFTOUT BLOCK & KEEPER SHIM	F-5063-3, 4	BAVARIAN	A.R.
13A	5062	FIXED PANEL SPACER	F-5062-1	BAVARIAN	A.R.
14	5091	ALUM. SCREEN ROLLER TRACK	F-5065-2	KEYMARK	1
15	5057	3/4" IG GLASS STOP	F-50xx-1	BAVARIAN	8
16	5058	7/8" IG GLASS STOP	F-50xx-1	BAVARIAN	8
17	5059	1" IG GLASS STOP	F-50xx-1	BAVARIAN	8
18	5060	1-1/8" IG GLASS STOP	F-50xx-1	BAVARIAN	8
19	5061	1-1/4" IG GLASS STOP	F-5061-1	BAVARIAN	8
20	5072	PANEL ROLLER TRACK	F-5072-1	KEYMARK	1
21	5090	RAIL/STILE REINFORCEMENT	F-5090-1, 2	KEYMARK	2/1
22	5093	STD. INTERLOCK REINFORCEMENT	F-5093-2	KEYMARK	2
22A	50112	H.D. INTERLOCK REINFORCEMENT	F-50112-2	KEYMARK	2
23	X	3/4" INSULATING GLASS	X	X	2
24	X	7/8" INSULATING GLASS	X	X	2
25	X	1" INSULATING GLASS	X	X	2
26	X	1-1/8" IG-IMPACT GLASS	X	X	2
27	X	1-1/4" TRIPLE ACoustICAL GLASS	X	X	2
28	X	ROLLING SCREEN	X	X	1
29	1936-C2	TANDEM ROLLER-15" WHEELS	STEEL/S.S.	AMESBURY	2
30	555(-84)-1912	SINGLEPOINT LOCK-PLATED & S.S.	X	AMESBURY	1
30A	2817(-84)-2450	MULTIPOINT LOCK-PLATED & S.S.	X	AMESBURY	1
31	2264 or 2496	KEEPERS- 2264/555; 2496/2817	X	AMESBURY	1
32	X	XXX HANDLE SET	X	AMESBURY	1
33	X	STRUCTURAL ADHESIVE/SEALANT	X	X	A.R.
34	.187" x .220"	HIGH-DENSITY CENTERFIN PILE	X	X	A.R.
35	.187" x .250"	HIGH-DENSITY CENTERFIN PILE	X	X	A.R.
36	0.125"x1.25"x2"	NEOPRENE SETTING BLOCK	X	X	A.R.
37	#8 x 5/8"	PAN HEAD TYPE A SCREW	ATTACH ROLLERS	X	2
38	#10 x 1-3/4"	PAN HEAD TYPE A SCREW	ATTACH KEEPER	X	2/3
39	#6 x 1"	FLAT HEAD TEK SCREW	SECURITY SCR.	X	5
40	X	INSTALLATION SCREW	X	X	A.R.
41	P-5085/P-5085-1	ADHESIVE-BACKED PILE PAD	45°/90° INTLK. CUT	X	2
42	5051	TRANSOM & SIDELITE FRAME	F-5051-10	X	4
43	5096	MULLION CONNECTOR	ST. CUT-NO FAB.	X	2
44	1/8" x 4"	ALUM. REINF. PLATE	X	X	A.R.
45	#8 x 1" TEK	FLAT HEAD TEK SCREW	MULL SCREWS	X	A.R.
46	#8 x 1-1/2"	PAN HEAD TYPE A SCREW	MECH FR. ASSY	X	12
47	P-5098	ADHESIVE-BACKED FOAM GASKET	SEAL FR. CORNERS	X	4
48	50100	MECH. FR. SCREW BOSS INSERT	DRIVE INTO SILL	KEYMARK	4

Do Not Scale Drawing Dimensions. All Dimensions in "[]" Are In Millimeter Equivalents.

Part No: 5050

Revision: N/A

Rev	By	App'd	Date	Revisions
A				
B				
C				

Area
0.000 in.²
Weight
0.000 lbs./ft.

Title: SERIES 5050 DX (XD) TWO-TRACK SGD

Drawing No: A-5050-14 w/AMESBURY HARDWARE

Scale: 1:1

Drawn By: RJK

Date: 6-21-12

Material: Poly-Vinyl Chloride (PVC)

BAVARIAN POLYMERS

Tolerances (Except As Noted)
Decimals: ± 0.010" [0.25mm]
Fractions: ± 1/100" [0.25mm]
Angles: ± 0° - 30°
Other: ± N/A